

10 Kg CO₂ Mobile Fire Extinguisher

- Robust
- For professional use in harsh environments

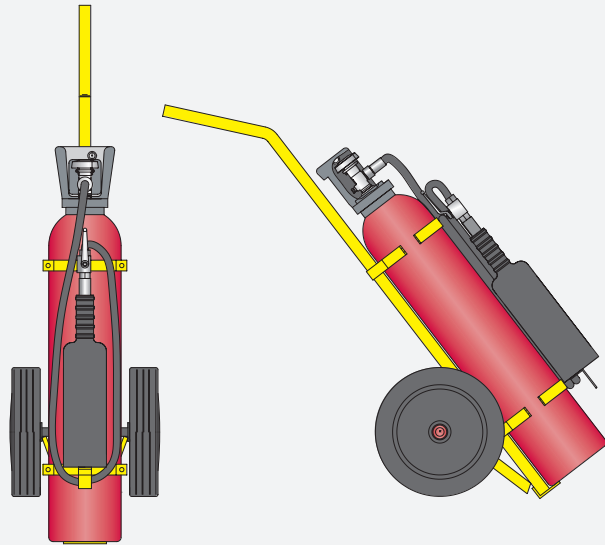

A high quality and robust mobile 10 Kg CO₂ gas extinguisher for professional use in harsh environments

Extinguishing medium

CO₂ gas
99% pure
Moisture less

Filled weight

Northern climates: 75% volume, 10 Kg
Tropical climates: 66% volume, 9 Kg

CO₂ cylinder

154mm Ø
Cold drawn steel 34Cr Mo4
Test pressure (hydraulic) >= 250 bar
T-PED approved

Cylinder valve

Material: Brass (to EN12420)
¾" handwheel
Safety valve set to 235 +/- 15 bar

Painting

Epoxy-polyester powder
Resistant to ultraviolet
Cylinders Red to RAL 3000
Frame Yellow to RAL 1003

Discharge hose

5m long x ¾" SAE 100 R1 AT
Discharge horn with insulated handle
Quarter turn operating valve with swivel

Frame

Welded steel "wrap around" frame
300mm Ø rubber rimmed wheels

Labelling



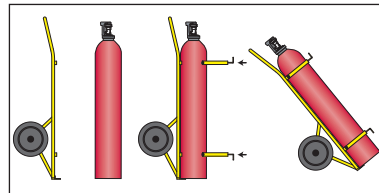

English/Arabic or English only

Corrosion often occurs where the support frame is welded to the cylinder causing it to be unsafe. Angus Fire mobiles use a wrap around frame to support the cylinder. During maintenance the frame can be removed for servicing or repair.

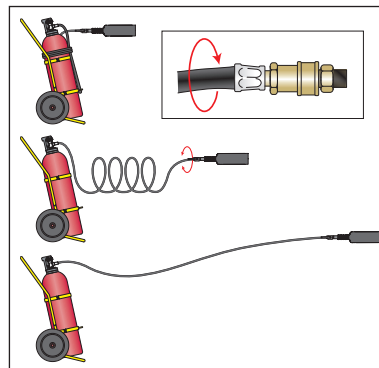

A swivel is fitted as standard on all Angus Fire mobiles between the discharge hose and the nozzle. When the coiled hose is unwound the hose can un-twist leaving the nozzle free to direct the jet.



	Inflammable liquids, gasoline, oil etc.
	Temperature range: -30°C to +60°C Operating pressure: 60 bar @ 20°C nominal
	Jet length: ~ 4m Discharge time: ~ 19 seconds
	Filled weight: 38 Kg Packed volume: 0.35 cum
	Width: 350mm Depth: 1045mm Height: 900mm

Options:

Dust cover
Extra length discharge hose 10m, 15m or 20m
Rigid 2m helicopter lance
Marine paint finish (minimum quantities)
MED Approval 

The full range of Angus mobile extinguishers includes:

50 l; 100 l AFFF Foam
50 kg; 75 kg; 100 kg ABC powder
35 kg; 50 kg; 70 kg Monnex™ powder
10 kg; 20 kg; 30 kg; 50 kg CO₂

INTERNATIONAL SALES

Angus Fire Ltd
Angus House, Haddenham Business Park,
Pegasus Way, Haddenham, Aylesbury, HP17 8LB, UK
Tel: +44 (0)1844 293600 • Fax: +44 (0)1844 293664

UK SALES

Angus Fire Ltd
Station Road, Bentham, Lancaster, LA2 7NA, UK
Tel: +44 (0)1524 264000 • Fax: +44 (0)1524 264180

Angus Fire operates a continuous programme of product development. The right is therefore reserved to modify any specification without prior notice and Angus Fire should be contacted to ensure that the current issues of all technical data sheets are used.

© Angus Fire
6607/5 02.14